

# Sample Specification

## Sanitary Manhole Chimney Reconstruction Within a Roadway/Paved Area (Asphalt Collar)

### Step #1 - Chimney Removal/Preparation

#### Existing Manhole with Adjusting Rings and Poor Vertical Alignment (Sectional View)

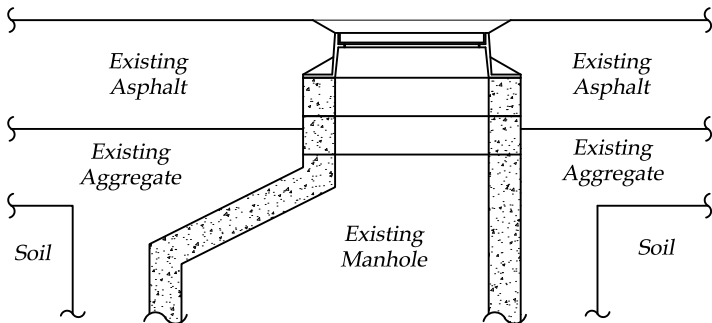

Legend  
 = Concrete

- Precautions must be taken to prevent debris from entering the manhole during the entire removal and reconstruction process. This will prevent the possibility of plugged sewers, interruptions in sewage flow and time required to remove the debris after construction.
- Cut and remove the asphalt pavement, around the existing manhole casting, in a circular fashion with a minimum diameter of 52" and centered about the casting. Comply with all applicable OSHA silica control regulations. Dispose of the asphalt.
- Remove the casting (manhole rim and cover) from the top of the manhole or manhole adjusting ring(s). Inspect the rim and cover for defects. If defects are present, replace with new rim/cover as needed. If defects are not present, clean & retain for use in reconstruction.
- Remove all adjusting rings to the top of the concrete cone. Dispose of this material
- Remove all aggregate around the manhole that has been exposed by the asphalt removal and dispose of this aggregate. The aggregate must be removed to a minimum of 3" below the level of the top of the concrete cone.
- Clean and inspect the top surface of the concrete cone. The surface should be smooth and free of bumps and pits that may prevent a good water tight seal. Grind the surface as needed to remove protrusions. Utilize compressed air to blow dust and debris from the surface after grinding. Clean the surface with acetone. Utilize a hydraulic cement, according to manufacturers recommendations, to fill in depressions.

#### Chimney Removed (Sectional View)

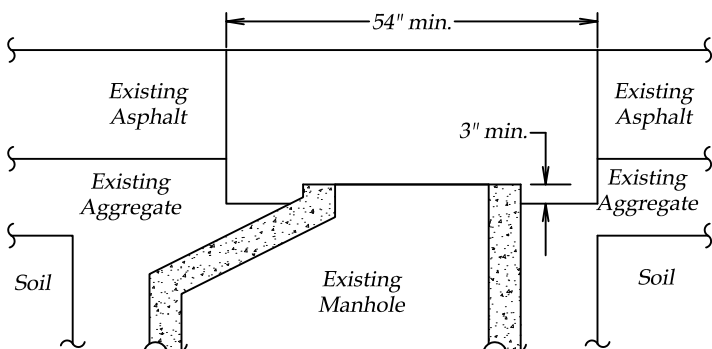

This Specification was prepared by Materials Testing, Inc.



*Brad J. Core*  
 Brad J. Core, P.E. #61122

# Sample Specification





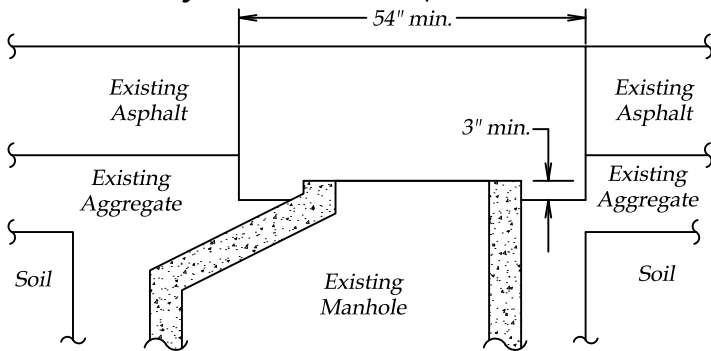

## Sanitary Manhole Chimney Reconstruction Within a Roadway/Paved Area (Asphalt Collar)

### Step #2 - Chimney Reconstruction

#### Chimney Removed (Sectional View)



#### Legend

-  = Concrete
-  = Epoxy Coated #4 Rebar
-  = Vylon® pipe that meets the specifications on sheet 3 of 3.
-  = ODOT #57 Aggregate
-  = Compacted Asphalt Collar
-  = Waterstop

- Bring the area around the cone back to flush with the top of the cone using ODOT #57 aggregate. This aggregate layer is intended to lessen the effects of freeze/thaw on the concrete collar by providing voids for excess water to expand into if subjected to freezing conditions. Manholes with excessive free water around them must be remediated on a case by case basis to further prevent freeze/thaw problems from occurring.
- A Vylon® pipe shall be used as a chimney liner and must be cut to the exact profile of the road in all directions such that when the manhole rim and cover are resting on top of the liner, the top of the casting shall be exactly 0.25" below flush with the pavement surface in all directions.
- The liner shall be marked in such a way, upon completion of the cutting process, that rotation does not occur, which could be detrimental to the end product. The top and/or bottom of the liner shall also be marked to prevent the liner from being installed up side down, which could be detrimental to the end product.
- Apply a liberal amount of white Mr. Manhole Sealant, MM 3006 to the bottom of the liner and set in place on top of the concrete cone while making sure it is properly aligned. This will create a water tight seal between the liner and the concrete cone.
- Apply a liberal amount of white Mr. Manhole Sealant, MM 3006 to the top of the liner. Set the manhole rim casting on the liner while making sure it is properly aligned. This will create a water tight seal between the liner and the manhole rim casting.
- Place the manhole lid on the rim casting to lessen the possibility of debris entering the manhole.
- Place Epoxy Coated #3 rebars as shown below. The circular shaped rebars shall have a 6" minimum overlap.
- Apply waterstop as shown below and specified on sheet 3 of 3. This will add an additional water tight seal where the liner meets the concrete cone.
- Utilize ODOT - Class C Concrete or Quikrete Fastset DOT Concrete Mix to cast a concrete collar around the liner. This will make the top surface of the concrete at the bottom of the casting. Finish smooth with a steel trowel and allow the concrete to harden to the touch.
- Apply Crete - Lease Bond Breaker - Xtra to the top of the concrete collar in accordance with manufacturer's recommendations.
- Barricade the area around the concrete to protect it during initial curing.
- Once the concrete attains a modulus of rupture of 400 pounds per square inch, the asphalt may be placed.
- Utilize a hotmix asphalt (ODOT 404) to finish the pavement repair. the completed asphalt shall make a smooth transition from the existing pavement to the casting in all directions. Seal the crack between the new and old asphalt with tar, which shall be continuously maintained to prevent water from getting between the asphalt and concrete collars and causing failure of the asphalt collar due to freeze/thaw.
- In order to minimize inconvenience to motorists and/or delays in the opening of new streets or parking lots, the manhole rebuilding contractor performing the work described in this specification must be capable of performing all of step #1 and all of step #2 of this specification, up through and including concrete placement, in 1.5 hours or less.
- In order to minimize water entering the manhole through the chimney, the chimney must be constructed by the manhole rebuilding contractor within 14 calendar days of the completion of finished paving.
- The manhole rebuilding contractor shall warrant the manhole chimney to be leak free and structurally sound for a minimum of 5 years from the date of construction.

#### Chimney Reconstruction (Sectional View)

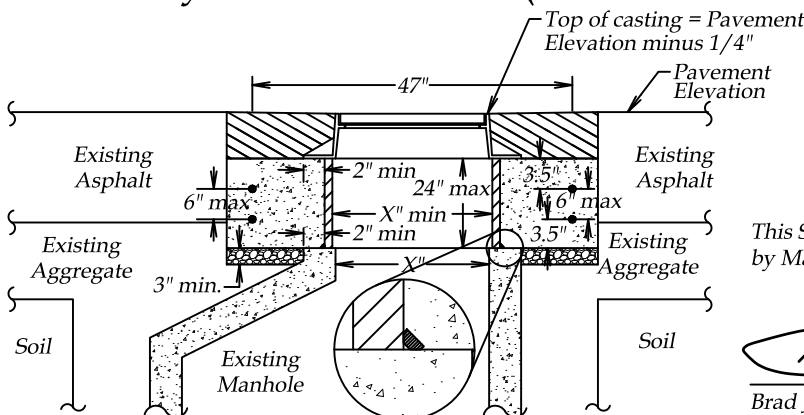

This Specification was prepared by Materials Testing, Inc.

  
Brad J. Core, P.E. #61122



# *Sample Specification*

## *Sanitary Manhole Chimney Reconstruction*

### *Within a Roadway/Paved Area*

*(Asphalt Collar)*

#### Chimney Liner Specifications:

The chimney liner shall be constructed of Vylon Pipe, or its equivalent. The chimney liner must be made from polyvinyl chloride compounds which comply with the requirements for a minimum cell classification of 12364 as defined by ASTM D-1784.

The chimney liner must also meet all the following physical requirements:

Pipe Stiffness - minimum pipe stiffness shall be 46 psi when tested in accordance with ASTM D-2412

Impact resistance - no visual cracking or splitting of the waterway wall shall be evidenced when tested in accordance with ASTM D-2444 with a 20 lb. weight, tup B, flat plate holder B to a level of 220 ft. lbs.

Fusion quality - there shall be no sign of flaking or disintegration when immersed in anhydrous acetone for 20 minutes as described in ASTM D-2152.

Ductility - there shall be no evidence of cracking or splitting when pipe is flattened in a circumferential orientation between two flat plates by sixty percent (60%) of the original diameter.

Air tightness - each length of pipe shall pass a factory 3.5 psi air test as described in ASTM F-1803.

#### Waterstop Specifications:

The waterstop shall be constructed of Swellstop 3/8" x 3/4" controlled expansion waterstop or equivalent. Swellstop is available from GREENSTREAK, 3400 Tree Court Industrial Blvd., St. Louis, MO 63122.

The waterstop must meet all of the following physical requirements:

Specific Gravity - shall be 1.55 +/- 5% when tested in accordance with ASTM D-71.

Volatile Matter - shall not exceed 1% when tested in accordance with ASTM D-6.

Application Temperature - must be able to be applied from -10 degrees F to 125 degrees F as a minimum.

Service Temperature - must be able to function properly in service from -30 degrees F to 180 degrees F as a minimum.